

SAMSUNG HOSPITALITY DISPLAYS HE690

HIGHLIGHTS

- Stylish design adds sophistication while maintaining guests' focus
- LYNK REACH 4.0 platform simplifies display management
- Expanded connectivity through Bluetooth and Ethernet compatibility
- Stream and share content from personal devices



CENTRALIZED DISPLAY MANAGEMENT

Hotels can leverage the centralized LYNK REACH 4.0 platform to manage content across multiple HE690 displays. This includes providing a range of IP- and RF-based channels to expand guests' available content viewing options.



PERSONALIZED IN-ROOM SERVICE

The LYNK REACH 4.0 platform empowers hotels to engage in personalized two-way communication with guests. Whether receiving a customized welcome message, navigating through on-site amenities or checking out, guests can enjoy a differentiated and tailored experience.



LOW-MAINTENANCE CONNECTIVITY

Expansive connectivity transforms the HE690 into a work or play station. An integrated Ethernet bridge establishes a secure, IP-compliant environment for business. Guests also can stream TV content or music (through Bluetooth) without interruption.

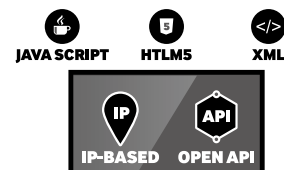

IP-BASED WEB SOLUTIONS

The embedded H.Browser open platform delivers superior in-room entertainment and customized content management without requiring a VoD set-top box. System integrators instead can establish IP-based web browsers to deliver premium interactive services without complication.



SECURE NETWORK PROTECTION

The HE690 display uses LYNK DRM technology as a safe, cost-efficient alternative to hardware-based content protection systems. As a result, encrypted live channel and VoD content can securely pass through the network and ultimately reach the in-room display.



EXTENSIVE MOBILE COMPATIBILITY

Integrated Software Access Point connectivity synchronizes the HE690 with up to four mobile devices for seamless content streaming. With screen mirroring feature, personal pictures, music and videos appear clearly on the larger screen, creating a more personalized in-room feel.

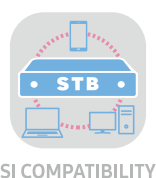

Contact us:
Tel: 0844870 7897 | Email: sales@hoteltvcompany.co.uk



SPECIFICATIONS

MODEL		24EE690 HG24EE690AB	28EE690 HG28EE690AB	32EE690 HG32EE690DB
Display	Inch	24"	28"	32"
	Resolution	1,366 x 768	1,366 x 768	1920 x 1080
Audio	Dolby Digital Plus	Yes	Yes	Yes
	Sound Output (RMS)	10W(L:5W, R:5W)	10W(L:5W, R:5W)	20W(L:10W, R:10W)
SMART TV	Smart TV Type	Smart	Smart	Smart
	Apps Panel	Yes	Yes	Yes
	Web Browser	Yes	Yes	Yes
VESA Standard	VESA Mount (mm)	75x75	100x100	100x100
Connectivity	Mobile to TV - Mirroring, DLNA	Yes	Yes	Yes
	Bluetooth Music Player (Mobile → TV)	N/A	N/A	Yes
	Samsung SMART View	Yes	Yes	Yes
Feature	EPG	Yes	Yes	Yes
	BT HID Support	N/A	N/A	Yes
System	Digital Broadcasting	DVB-T2/C/S2	DVB-T2/C/S2	DVB-T2/C/S2
	Analog Tuner	Yes	Yes	Yes
	CI (Common Interface)	CI+(1.3)	CI+(1.3)	CI+(1.3)
Hospitality Feature	Samsung LYNK™ SINC Compatibility	Yes	Yes	Yes
	Samsung LYNK™ HMS Compatibility	N/A	N/A	Yes
	H.Browser	Yes	Yes	Yes
	Samsung LYNK™ REACH (IP)	REACH4.0	REACH4.0	REACH4.0
	Samsung LYNK™ REACH (RF)	REACH4.0	REACH4.0	REACH4.0
	Samsung LYNK™ REACH RF Modulator Compatibility	Yes	Yes	Yes
	Hospitality Home Menu	Home Menu 2015	Home Menu 2015	Home Menu 2015
	Mixed Channel List (ATSC, DVB-T/T2/C/S2, Analog)	Yes	Yes	Yes
	Welcome Message	Yes	Yes	Yes
	RJ12/IR pass through	Yes	Yes	Yes
	External Clock Compatibility	N/A	Yes	Yes
	USB Cloning	Yes	Yes	Yes
Input & Output	USB	1/0	2/0	2/0
	Component In (Y/Pb/Pr)	N/A	N/A	0/1
	Composite In (AV)	N/A	1/0	0/1 (Common Use for Component Y)
	Ethernet (LAN)	1/0	1/0	1/0
	Variable Audio Out	N/A	0/1	1/0
	RJ12	0/1	0/1	0/1
	RJP(For Remote Jackpack)	0/1	0/1	1/0
	Headphone ID	0/1	0/1	0/1
	PC In (D-sub)	0/1	0/1	0/1
	PC/DVI Audio In (Mini Jack)	0/1	0/1	0/1
	Ethernet Bridge (LAN-Out)	N/A	N/A	0/1
Stand	Swivel (Left/Right)	N/A	N/A	90/90
Eco	Energy Efficiency Class	A	A	A
Dimension	Set Size without Stand - Speaker Side (WxHxD)(mm)	561.8*349.1*66.6	643.4 x 396.5 x 62.9	730.4 * 433.8 * 54.6
	Set Size with Stand (WxHxD)(mm)	561.8*383.5*163.7	643.4 x 435.0 x 163.4	730.4 * 482.8 * 192.6
	Package Size (WxHxD)(mm)	743 * 407 * 114	815 x 463 x 108	913 * 534 * 113

SPECIFICATIONS

MODEL		43EE690 HG43EE690DB	49EE690 HG49EE690DB	55EE690 HG55EE690DB
Display	Inch	43 (42.5)	49"	55"
	Resolution	1920 x 1080	1920 x 1080	1920 x 1080
Audio	Dolby Digital Plus	Yes	Yes	Yes
	Sound Output (RMS)	20W(L:10W, R:10W)	20W(L:10W, R:10W)	20W(L:10W, R:10W)
SMART TV	Smart TV Type	Smart	Smart	Smart
	Apps Panel	Yes	Yes	Yes
	Web Browser	Yes	Yes	Yes
VESA Standard	VESA Mount (mm)	200x200	200x200	400x400
Connectivity	Mobile to TV - Mirroring, DLNA	Yes	Yes	Yes
	Bluetooth Music Player (Mobile → TV)	Yes	Yes	Yes
	Samsung SMART View	Yes	Yes	Yes
Feature	EPG	Yes	Yes	Yes
	BT HID Support	Yes	Yes	Yes
System	Digital Broadcasting	DVB-T2/C/S2	DVB-T2/C/S2	DVB-T2/C/S2
	Analog Tuner	Yes	Yes	Yes
	CI (Common Interface)	CI+(1.3)	CI+(1.3)	CI+(1.3)
Hospitality Feature	Samsung LYNK™ SINC Compatibility	Yes	Yes	Yes
	Samsung LYNK™ HMS Compatibility	Yes	Yes	Yes
	H.Browser	Yes	Yes	Yes
	Samsung LYNK™ REACH (IP)	REACH4.0	REACH4.0	REACH4.0
	Samsung LYNK™ REACH (RF)	REACH4.0	REACH4.0	REACH4.0
	Samsung LYNK™ REACH RF Modulator Compatibility	Yes	Yes	Yes
	Hospitality Home Menu	Home Menu 2015	Home Menu 2015	Home Menu 2015
	Mixed Channel List (ATSC, DVB-T/T2/C/S2, Analog)	Yes	Yes	Yes
	Welcome Message	Yes	Yes	Yes
	RJ12/IR pass through	Yes	Yes	Yes
	External Clock Compatibility	Yes	Yes	Yes
Input & Output	USB	2/0	2/0	2/0
	Component In (Y/Pb/Pr)	0/1	0/1	0/1
	Composite In (AV)	0/1 (Common Use for Component Y)	0/1 (Common Use for Component Y)	0/1 (Common Use for Component Y)
	Ethernet (LAN)	1/0	1/0	1/0
	Variable Audio Out	1/0	1/0	1/0
	RJ12	0/1	0/1	0/1
	RJP(For Remote Backpack)	1/0	1/0	1/0
	Headphone ID	0/1	0/1	0/1
	PC In (D-sub)	0/1	0/1	0/1
	PC/DVI Audio In (Mini Jack)	0/1	0/1	0/1
	Ethernet Bridge (LAN-Out)	0/1	0/1	0/1
Stand	Swivel (Left/Right)	90/90	90/90	90/90
Eco	Energy Efficiency Class	A+	A++	A++
Dimension	Set Size without Stand - Speaker Side (WxHxD)(mm)	972.9 * 570.1 * 54.0	1105.8 * 645.0 * 54.6	1241.6 * 721.4 * 54.5
	Set Size with Stand (WxHxD)(mm)	972.9 * 622.0 * 226.5	1105.8 * 697.0 * 226.5	1241.6 * 773.3 * 226.5
	Package Size (WxHxD)(mm)	1170 * 653 * 118	1290 * 746 * 130	1424 * 812 * 140

SPECIFICATIONS

HG24EE690AB

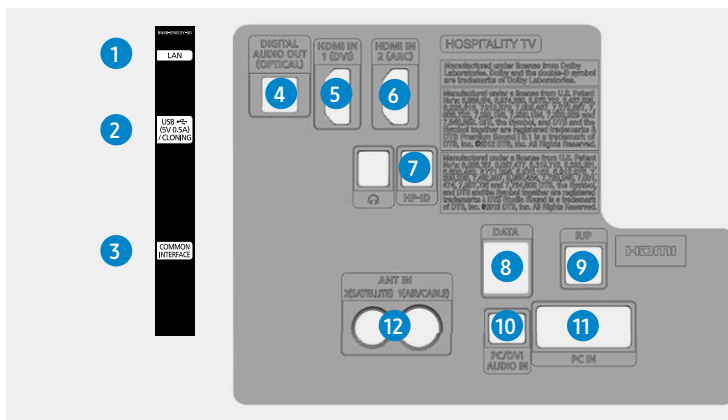
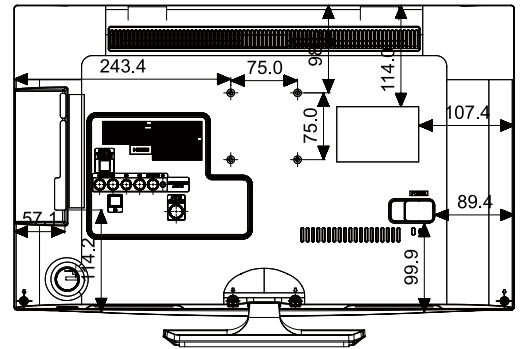
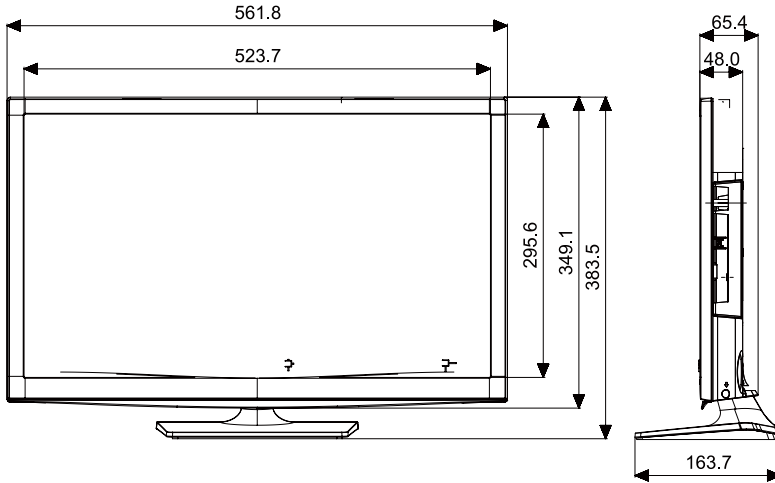

CONNECTORS

- | | |
|--------------------------------|------------|
| 1. LAN | 12. ANT IN |
| 2. USB (5V 0.5A) / CLONING | |
| 3. COMMON INTERFACE | |
| 4. DIGITAL AUDIO OUT (OPTICAL) | |
| 5. HDMI IN1 (DVI) | |
| 6. HDMI IN1 (ARC) | |
| 7. HP-ID | |
| 8. DATA | |
| 9. RJP | |
| 10. PC/DVI AUDIO IN | |
| 11. PC IN | |

HG28EE690AB

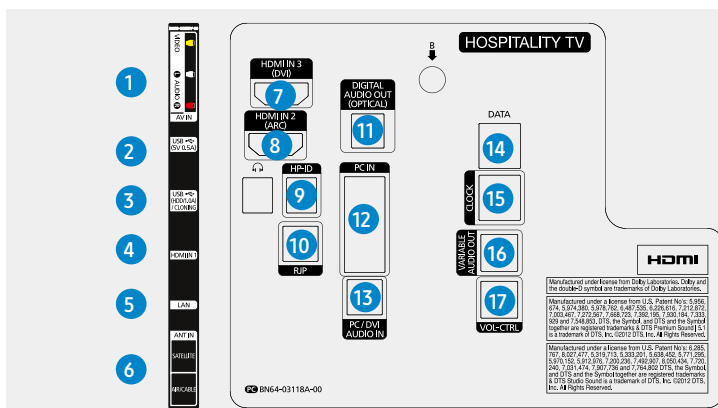
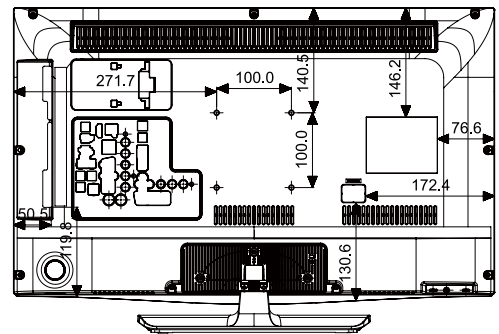
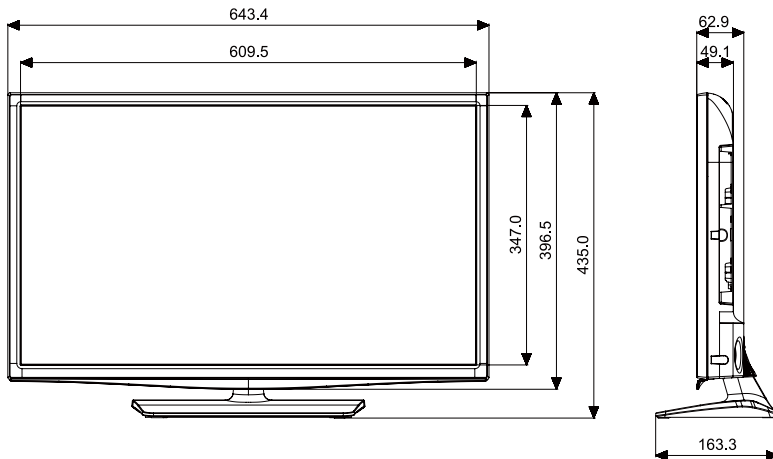

CONNECTORS

- | | |
|---------------------------------|------------------------|
| 1. AV IN | 12. PC IN |
| 2. USB (5V 0.5A) | 13. PC / DVI AUDIO IN |
| 3. USB (HDD 1.0A) / CLONING | 14. DATA |
| 4. HDMI IN1 | 15. CLOCK |
| 5. LAN | 16. VARIABLE AUDIO OUT |
| 6. ANT IN | 17. VOL-CTRL |
| 7. HDMI IN3 (DVI) | |
| 8. HDMI IN2 (ARC) | |
| 9. HP-ID | |
| 10. RJP | |
| 11. DIGITAL AUDIO OUT (OPTICAL) | |

SPECIFICATIONS

HG32EE690DB

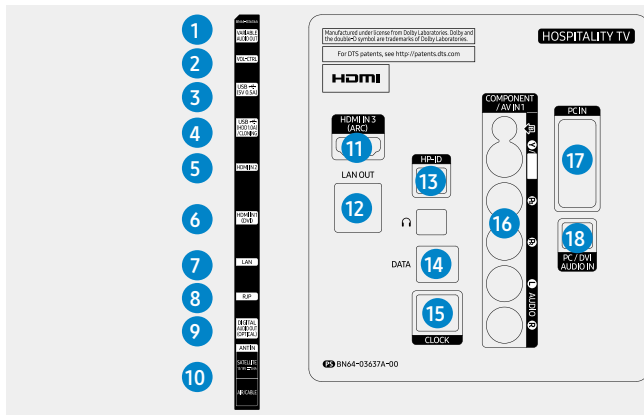
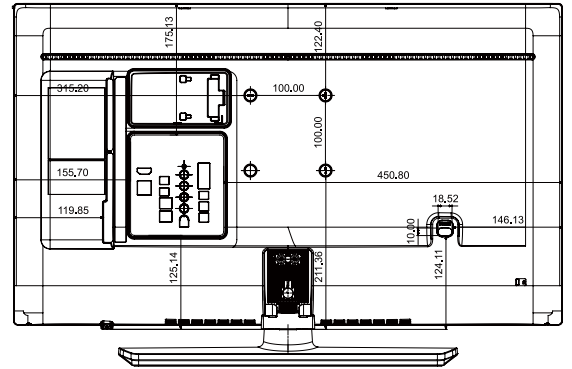
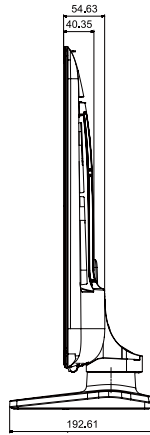
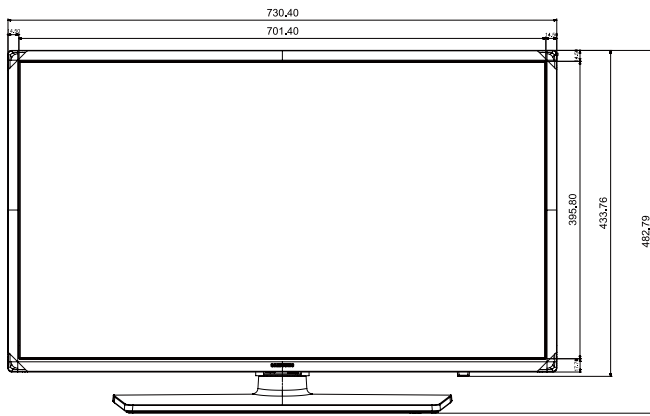

CONNECTORS

- | | |
|----------------------------------|------------------------|
| 1. VARIABLE AUDIO OUT | 12. LAN OUT |
| 2. VOL-CTRL | 13. HP-ID |
| 3. USB (5V 0.5A) | 14. DATA |
| 4. USB (HDD1.0A)/CLONING | 15. CLOCK |
| 5. HDMI IN2 | 16. COMPONENT / AV IN1 |
| 6. HDMI IN1 (DVI) | 17. PC IN |
| 7. LAN | 18. PC/DVI AUDIO IN |
| 8. RJP | |
| 9. DIGITAL AUDIO OUT(OPTICAL) | |
| 10. ANT IN (SATELLITE,AIR/CABLE) | |
| 11. HDMI IN3 (ARC) | |

HG43EE690DB

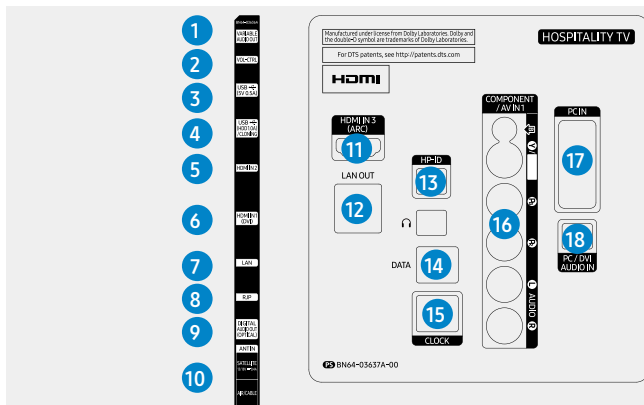
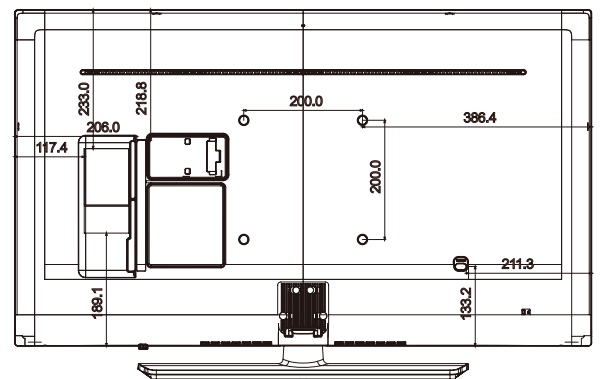
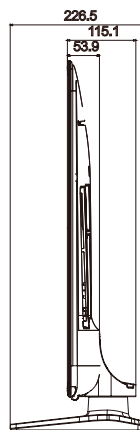
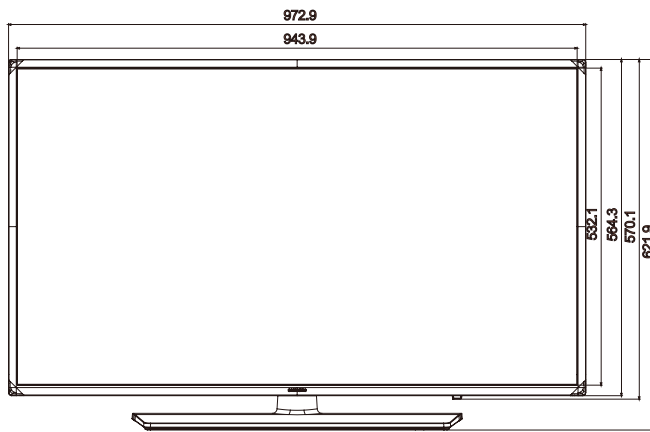

CONNECTORS

- | | |
|----------------------------------|------------------------|
| 1. VARIABLE AUDIO OUT | 12. LAN OUT |
| 2. VOL-CTRL | 13. HP-ID |
| 3. USB (5V 0.5A) | 14. DATA |
| 4. USB (HDD1.0A)/CLONING | 15. CLOCK |
| 5. HDMI IN2 | 16. COMPONENT / AV IN1 |
| 6. HDMI IN1 (DVI) | 17. PC IN |
| 7. LAN | 18. PC/DVI AUDIO IN |
| 8. RJP | |
| 9. DIGITAL AUDIO OUT(OPTICAL) | |
| 10. ANT IN (SATELLITE,AIR/CABLE) | |
| 11. HDMI IN3 (ARC) | |

SPECIFICATIONS

HG49EE690DB

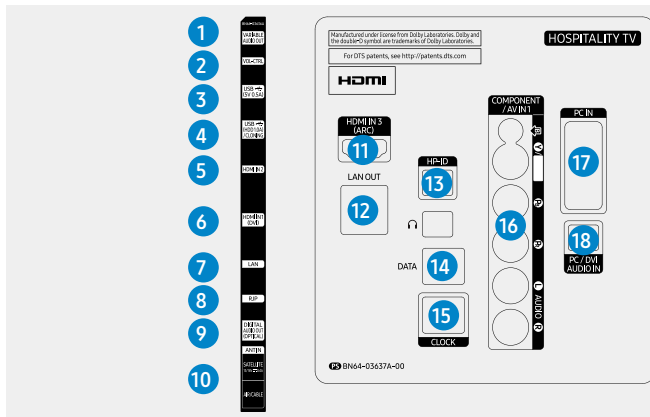
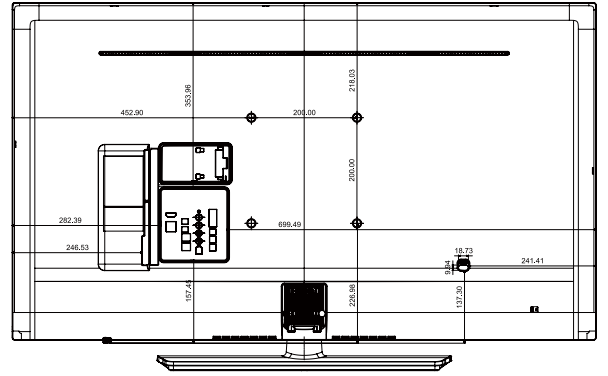
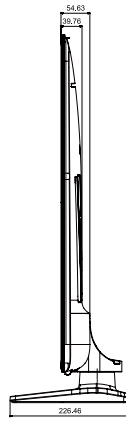
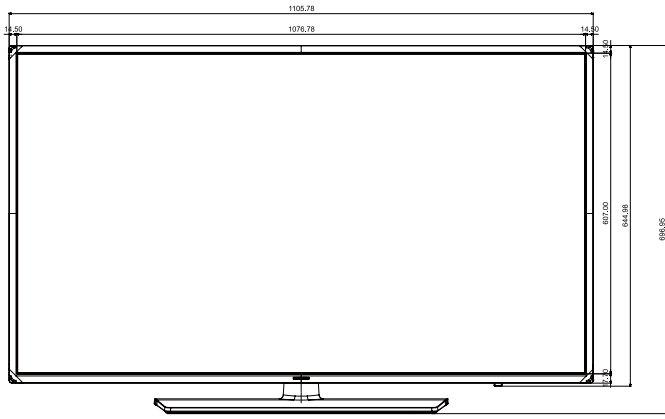

CONNECTORS

- | | |
|----------------------------------|------------------------|
| 1. VARIABLE AUDIO OUT | 12. LAN OUT |
| 2. VOL-CTRL | 13. HP-ID |
| 3. USB (5V 0.5A) | 14. DATA |
| 4. USB (HDD1.0A)/CLONING | 15. CLOCK |
| 5. HDMI IN2 | 16. COMPONENT / AV IN1 |
| 6. HDMI IN1 (DVI) | 17. PC IN |
| 7. LAN | 18. PC / DVI AUDIO IN |
| 8. RJP | |
| 9. DIGITAL AUDIO OUT(OPTICAL) | |
| 10. ANT IN (SATELLITE,AIR/CABLE) | |
| 11. HDMI IN3 (ARC) | |

HG55EE690DB

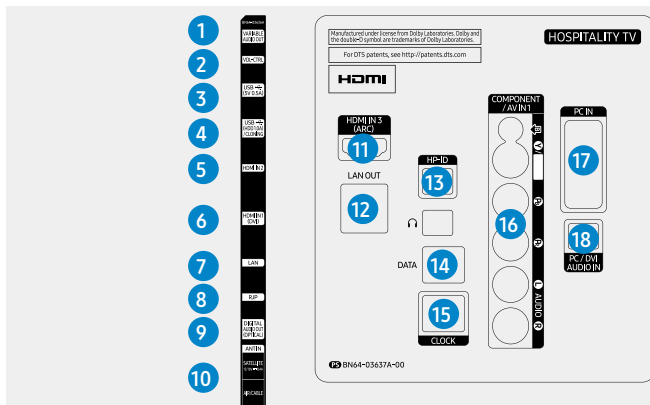
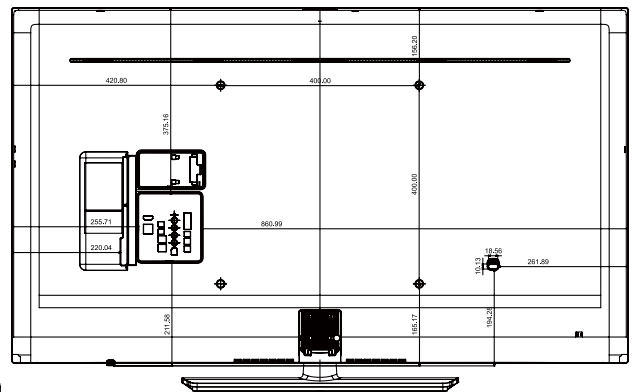
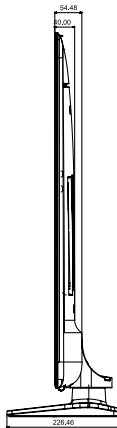
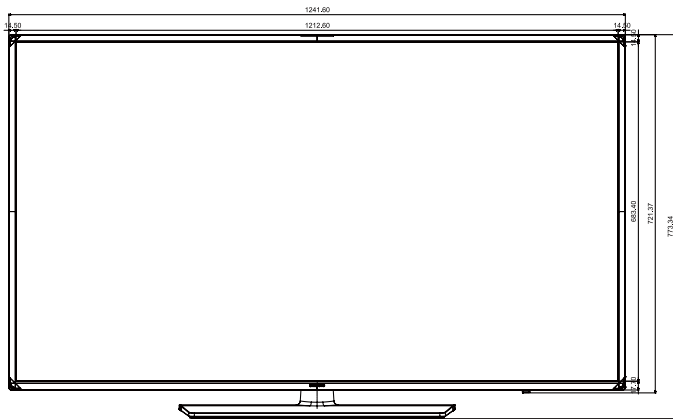

CONNECTORS

- | | |
|----------------------------------|------------------------|
| 1. VARIABLE AUDIO OUT | 12. LAN OUT |
| 2. VOL-CTRL | 13. HP-ID |
| 3. USB (5V 0.5A) | 14. DATA |
| 4. USB (HDD1.0A)/CLONING | 15. CLOCK |
| 5. HDMI IN2 | 16. COMPONENT / AV IN1 |
| 6. HDMI IN1 (DVI) | 17. PC IN |
| 7. LAN | 18. PC / DVI AUDIO IN |
| 8. RJP | |
| 9. DIGITAL AUDIO OUT(OPTICAL) | |
| 10. ANT IN (SATELLITE,AIR/CABLE) | |
| 11. HDMI IN3 (ARC) | |

NOTE.

ABOUT SAMSUNG ELECTRONICS CO., LTD.

Samsung Electronics Co., Ltd. inspires the world and shapes the future with transformative ideas and technologies. The company is redefining the worlds of TVs, smartphones, wearable devices, tablets, cameras, digital appliances, medical equipment, network systems, and semiconductor and LED solutions. For the latest news, please visit Samsung Newsroom at <http://news.samsung.com>

HOSPITALITY DISPLAY

For more information about Samsung Hospitality Displays, visit www.samsung.com/business or www.samsung.com/displaysolutions

Copyright © 2017 Samsung Electronics Co. Ltd. All rights reserved. Samsung is a registered trademark of Samsung Electronics Co. Ltd. Specifications and designs are subject to change without notice. Non-metric weights and measurements are approximate. All data were deemed correct at time of creation. Samsung is not liable for errors or omissions. All brand, product, service names and logos are trademarks and/or registered trademarks of their respective owners and are hereby recognized and acknowledged.

Samsung Electronics Co., Ltd.
416, Maetan 3-dong, Yeongtong-gu
Suwon-si, Gyeonggi-do 443-772, Korea

2018-01



Scan this code with your smartphone to download the Samsung Display Solutions Mobile App.